

METALMASTER

MECHANICAL GUILLOTINE OPERATION MANUAL



Models.
MG-440, MG-840

Edition No : MGG-1

Date of Issue : 10/2016

www.machineryhouse.com.au



OPERATION MANUAL

MACHINE DETAILS

MACHINE	MECHANICAL GUILLOTINE
MODEL NO.	
SERIAL NO.	
DATE OF MANF.	

Distributed by



www.machineryhouse.com.au

www.machineryhouse.co.nz

Note:

This manual is only for your reference. Owing to the continuous improvement of the machine, changes may be made at any time without obligation or notice. Please ensure the local voltage is the same as listed on the specification plate before operating this electric machine.



NOTE:

In order to see the type and model of the machine, please see the specification plate. Usually found on the back of the machine. See example (Fig.1)

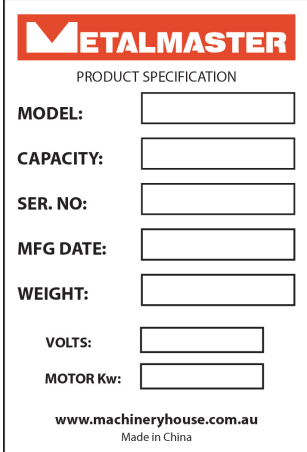

METALMASTER
PRODUCT SPECIFICATION

MODEL:

CAPACITY:

SER. NO:

MFG DATE:

WEIGHT:

VOLTS:

MOTOR Kw:

www.machineryhouse.com.au
Made in China

Fig.1



OPERATION MANUAL

CONTENTS:

1. GENERAL MACHINE INFORMATION	
1.1 Specifications.....	4
1.2 Standard Equipment.....	4
1.3 Overall Drawings.....	5
2. IMPORTANT INFORMATION	
2.1 Safety Requirements.....	6
2.2 Features of the Machine.....	8
2.3 Lifting Instructions.....	9
3. INSTALLATION	
3.1 Base Foundation and Securing Points.....	10
3.2 Machine Leveling.....	11
3.3 Checking the Power Supply.....	11
3.4 Attaching The Accessories.....	12
4. COMMISSIONING	
4.1 Preparation of the Machine.....	13
4.2 Omrom E3z Safety Sensor Alignment.....	13
4.3 Manual Back Gauge.....	16
4.4 Commissioning Check List.....	16
5. OPERATION INSTRUCTION	
5.1 Pre-Operational Safety Check Prior to Operating..	17
5.2 Start Up.....	18
5.3 Adjusting Of The Blade Gap.....	19
6. MAINTAINANCE	
6.1 Type And Frequency Of Inspections.....	20
6.2 Lubrication Points.....	21
6.3 Brake Adjustment.....	22
6.4 Calibrate Rapid Blade Adjustment Dial.....	23
6.5 Top Position Cam Adjustment.....	24
APPENDIX	
A. Electrical Diagram.....	25
Risk Assessment Sheets.....	26



OPERATION MANUAL

1.1 SPECIFICATIONS:

Machine Type	MG-440	MG-840
Shearing Length (mm)	1300	2500
Material Capacity Mild Steel (mm)	4	4
Material Capacity Stainless Steel (mm)	2.5	2.5
Shear Angle (degree)	2	2
Back Gauge Range (mm)	750	750
Back Gauge Type	Rack & Pinion	Rack & Pinion
Strokes per Minute	22	28
Dimensions		
Width (mm)	1860	3124
Depth (mm)	2210	2398
Height (mm)	1180	1290
Weight (kgs)	1440	2500
Main Motor 3 Phase 415 Volt 50Hz (kW)	4	7.5
Back Gauge	Manual	Manual

1.2. Standard Equipment:

Instruction Manual
 Back-gauge assembly
 Front guarding
 Footswitch and control panel



OPERATION MANUAL

1.3 OVERALL DRAWING

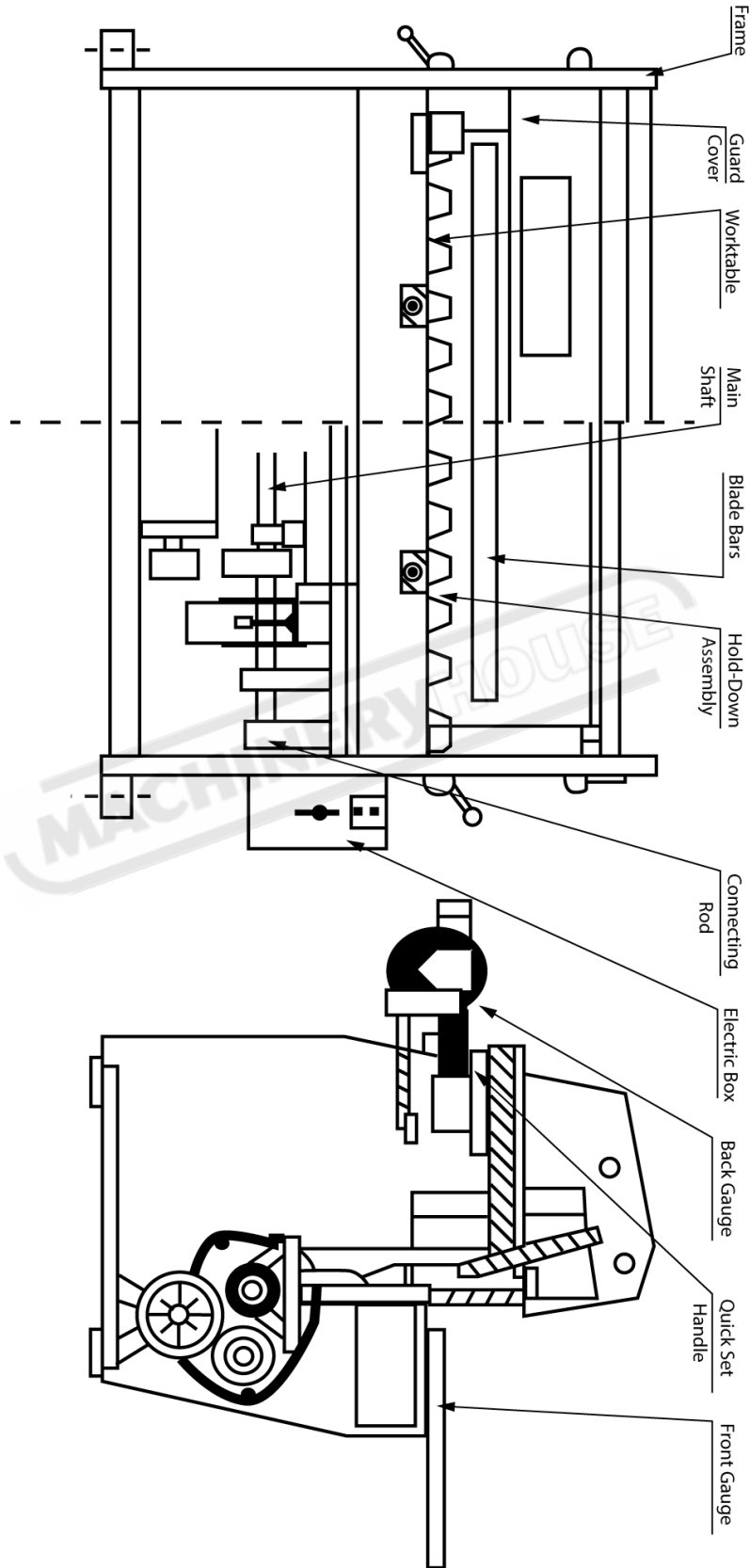

METALMASTER

OPERATION MANUAL

2.1 SAFETY REQUIREMENTS

DO NOT use this machine unless a Qualified person has instructed you in its safe use and operation of the machine.

The most common metal guillotine injuries are crushed or amputated fingers.

Most of these accidents are not caused by the blade of the guillotine, but by the clamps that hold the sheet metal being cut. Other injuries are from fingers jamming under the sheet that is to be cut, and strain injuries while handling large and awkward sheets of metal.

By law, guillotines must be guarded, and operators must be trained. Safe working procedures must be developed to prevent injuries.



Safety glasses must be worn at all times in work areas. Earmuffs should be worn if the work area is noisy.



Sturdy footwear must be worn at all times in work areas.



Gloves should be worn when handling the material used on this machine.



Long and loose hair must be contained with a net or under a hat

The following topics can be used as a guide to identify workplace hazards and to reduce the risks of operating metal guillotines.

It is an unsafe practice for two people to work at a guillotine unless both operators are provided with interlocked actuating devices (usually a foot control). However in some guillotine operations, for example cutting large sheets, two operators may be required to maneuver sheets into position before cutting. For such operations safe work procedures should be developed to control any hazards.





OPERATION MANUAL

SAFETY CHECKS BEFORE OPERATING

- Ensure fixed guards are in place to prevent hands or other parts of the body from entering the trapping space.
- Guards or safety devices must never be removed or adjusted, except by an authorized person for maintenance purposes.
- Working parts should be well lubricated and free of rust and dirt.
- The area around the machine must be adequately lit and kept free of materials, which might cause slips or trips.
- Be aware of other personnel in the immediate vicinity and ensure the area is clear before using equipment.
- Familiarize yourself with and check all machine operations and controls.
- Ensure cutting table is clear of scrap and tools.
- Faulty equipment must not be used. Immediately report suspect machinery

SAFETY CHECKS WHEN OPERATING

- Do not attempt to cut material beyond the capacity of the machine.
- Never attempt to cut rod, strap or wire with this machine.
- Use correct lifting procedures when handling large sheets of material.
- Take extreme care during the initial feeding of the workpiece into the machine.
- The workpiece should always be held sufficiently far back from the edge being fed into the guillotine.
- Ensure fingers and limbs are clear before actuating the guillotine.
- Hold material firmly to prevent inaccurate cutting due to creep.
- When cutting ensure feet are positioned to avoid contact with the foot operated lever.

SAFETY CHECKS AFTER OPERATION

- Remove all off cuts and place them in either the storage rack or waste bin.
- Leave the work area in a safe, clean and tidy state.

POTENTIAL HAZARDS

- Cuts from the sharp edges and burrs on the sheets before and after cutting
- Parts of the body being caught in crush and pinch points.
- Injuries caused when handling metal sheets



OPERATION MANUAL

2.2. FEATURES OF THE MACHINE:

The electrical circuits of your machine are designed to allow operation with maximum safety. The following precautions are available on the machine for enhanced safety.

There are three Emergency stop buttons (engaging type). They are found on the foot switch, control unit, and on the front of the machine. Once the buttons has been pressed to reset the emergency stop, the red button must be rotated.

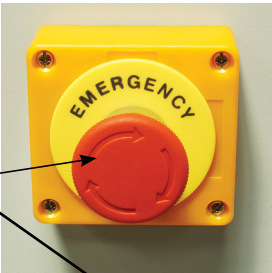

Foot pedal control

The foot pedal when pressed activates the beam and must be held in the depressed position until the machine has completed its cut.

Release the foot pedal during the cutting operation and the blade will stop and stay in that position. To make it return to the top of the stroke the foot pedal must be pressed again and held until the cycle has been completed.



Main Controls

The main machine operating controls are located on the front of the machine.

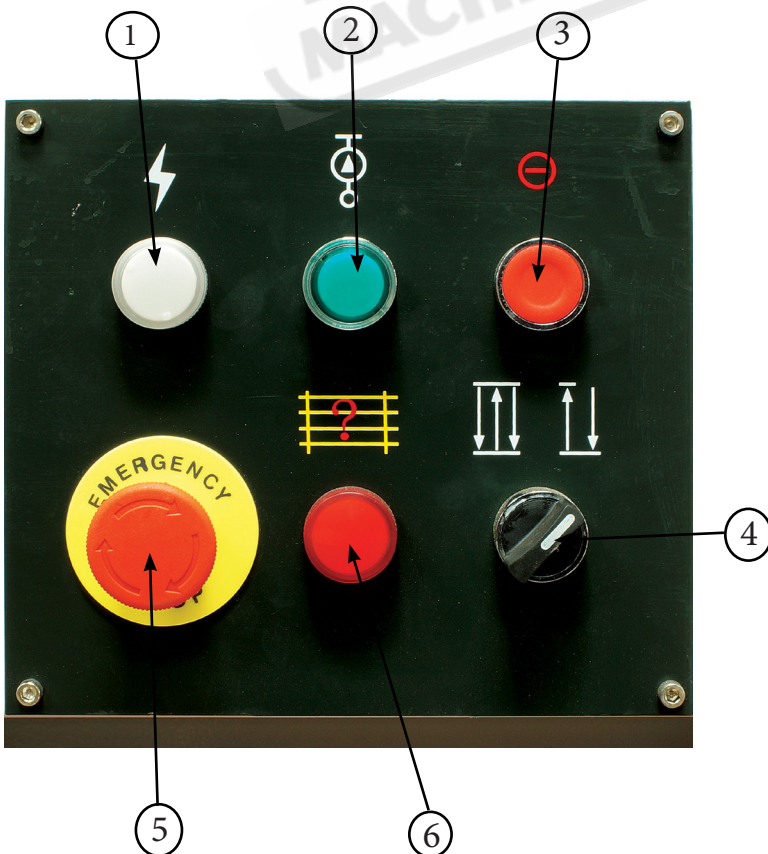

1	Power ON Light
2	Illuminated Start Button
3	Electrics OFF
4	Continuous or Single cut
5	Emergency Stop
6	Rear Safety Guard



OPERATION MANUAL

2.3 LIFTING INSTRUCTIONS

On the day that the machine arrives, make sure that a crane with sufficient capacity is available to unload the machine from the vehicle. Ensure access to the chosen site is clear and that doors and ceilings are sufficiently high and wide enough to receive the machine.

To handle the Guillotine, use only the two sling lifting points located on the top of the end plates. (Fig. 2.3) The slings should be positioned so the machine is level when lifted.

When using slings please take note of the sling angle and the loads that apply

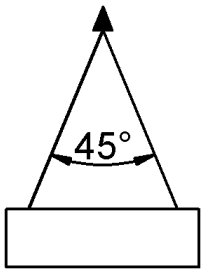

Fig 2.1.

When the slings are at a 45° angle then each sling is carrying the equivalent of 50% of the load weight. (Fig.2.1).

When the slings are at a 90° angle then each sling will have a weight equal to 75% of the load on each sling.

(Fig 2.2)

Note! Metalmaster recommend not to exceed 90° angle

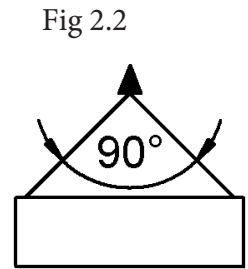

Fig 2.2

Fig. 2.3

Lifting Points

When lifting the machine use only certified lifting slings
Ensure that when lifting, the machine does not tip over.
Check that the lifting slings do not interfere with the hydraulic pipes or electrical conduits.
Failure to follow these instructions could cause damage to the machine





OPERATION MANUAL

3. INSTALLATION

The machine is delivered in a complete assembled execution. It must be leveled and firmly stationed on the floor where it is to be used, according to the Installation Diagram attached. Indoor installation and a dry working environment without danger of fire and explosion is necessary. The floor load, where the machine is to be installed, must be suitable for the weight of the machine.

3.1 BASE FOUNDATION AND SECURING POINTS

Before securing the machine a solid concrete base must be prepared to the specification of the machine.

The sizes for the bolt holes position are listed as A-B.

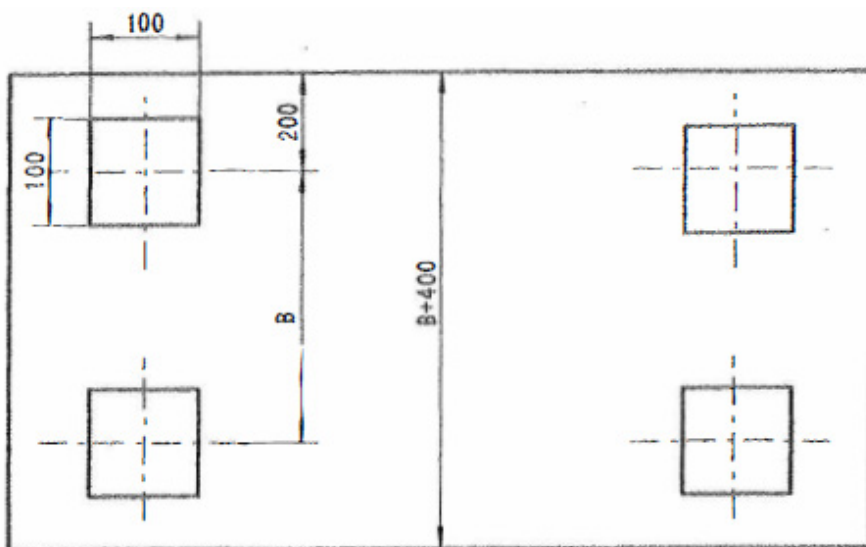
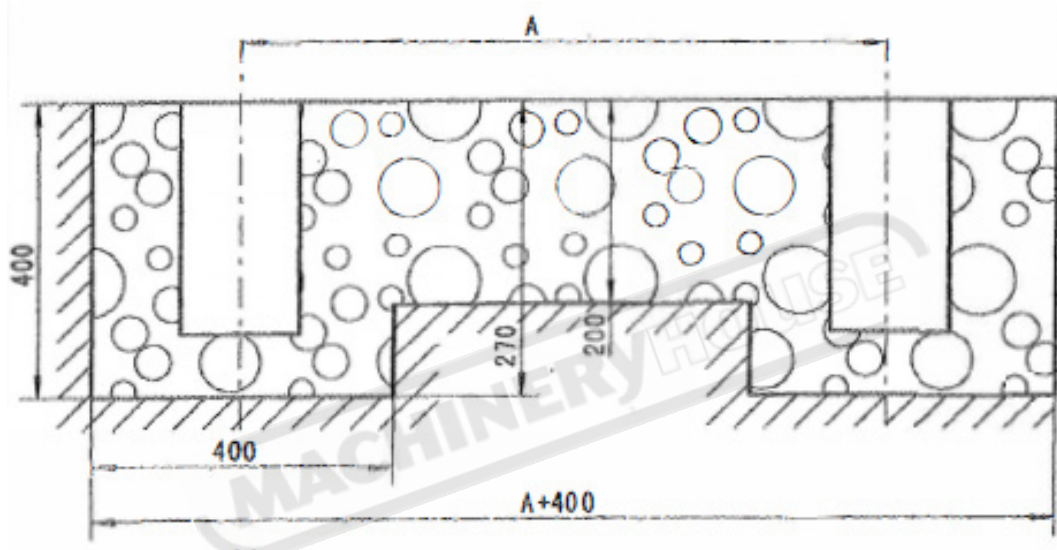

Size	A	B
1250 1300	1640	500
2000	2040	500
2500	2504	500
3000 3050	3379	625



OPERATION MANUAL

3.2 MACHINE LEVELING

To set your machine up so that it operates to optimum performance, apply the following procedure. After your guillotine has been anchored to a concrete slab floor, it then needs to be leveled. The leveling is performed using each of the screws on each pad. (Fig. 3.1). Loosen the hold down bolts and place a level on the surface of the working table. Tolerances: 1000:0.30mm, for both longitudinal and transverse.

Metal plates need to be placed under each jacking screw to distribute the load. Once level then tighten the hold down bolts.

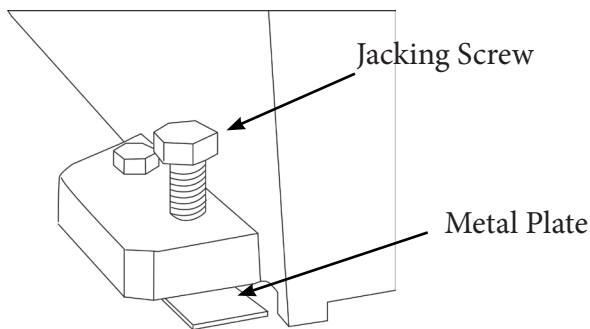

The machine must not rest on supports other than those defined in Fig. 3.1

Fig. 3.1

3.3 Checking The Power Supply

METALMASTER machines are supplied wired ready to run. Check the specification plate on the machine to confirm the correct voltage of the power supply.

Check the rotation of the motor is correct.

The machine must be connected to the power only by a qualified and licensed electrician.

Warranty may be voided if it is found that the connection was not carried out by a qualified electrician.



3.4 ATTACHING THE ACCESSORIES.

- ❑ Bolt the support arms onto the feed table. Ensure they are level and square to the table. (Fig 3.2)

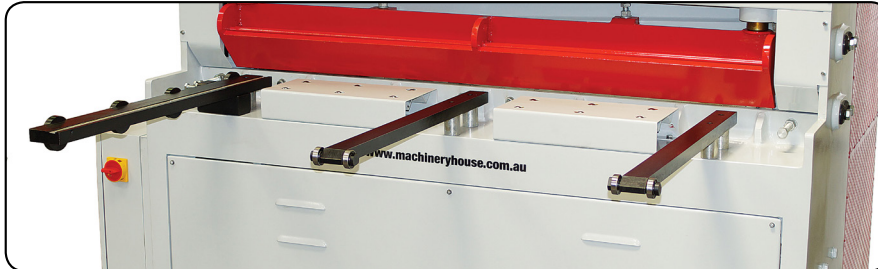

Fig. 3.2

- ❑ Place the squaring stops Fig 3.3 into position on the table top, securing into place with the bolts supplied. Check that the square stops are square to the blade. Adjust by loosening the bolts and moving by the amount allowed by the clearance of the holes.
- ❑ Re tighten the screws.



Fig. 3.3

- ❑ Unpack and attach the rear fence to the back of the machine. Ensure that the sensors have been connected and set up. (Fig.3.4)
- ❑ Unpack the mobile foot control and plug the into the socket provided on the machine. (Fig.3.5)

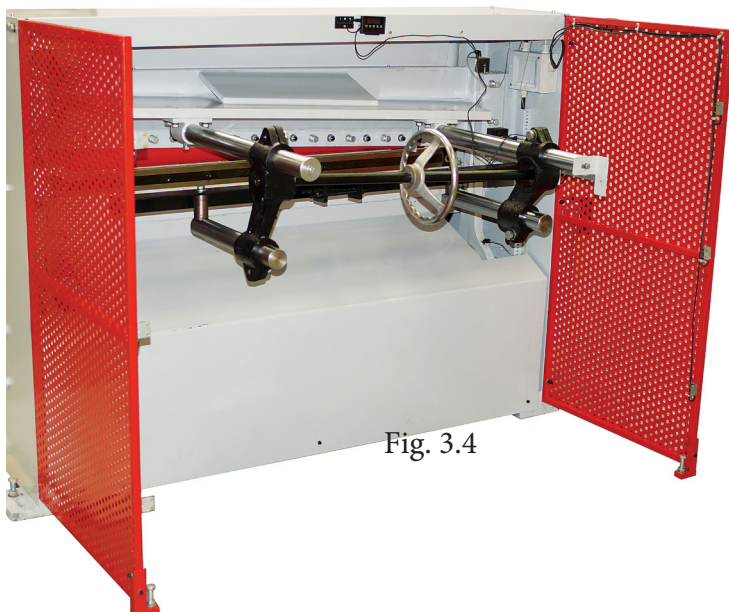

Fig. 3.4



Fig. 3.5



OPERATION MANUAL

4. COMMISSIONING

4.1. PREPARATION OF THE MACHINE.

- Remove all wrapping and packing grease from the machine.
- Check the machine for loose bolts. Tighten as required.
- Check the top return position is correct.
- Clean the blades and tighten the securing bolts as required. Examine the cutting edges of both blades for damage.
- Inform your service provider of any damage or faults with the machine.

4.2 OMROM E3Z SAFETY SENSOR ALIGNMENT

Warning- Follow all setup instructions before starting the machine

The safety circuit consists of a reset switch and two rear side guards, each having 3 sensors. Your machine will have a RED warning light on the main control panel. When the main power is switched on or the rear sensors have been tripped the safety circuit must be reset before the motor can be started.

Warning Indication: The safety circuit has not been Reset.

Red Warning Light



Reset Switch

Press the “Reset Rear Guard” button on the back of the electrical cabinet to reset the safety circuit

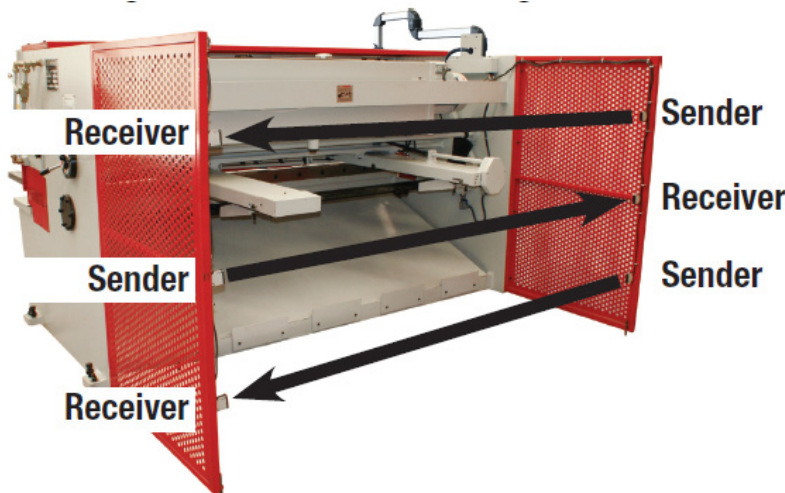
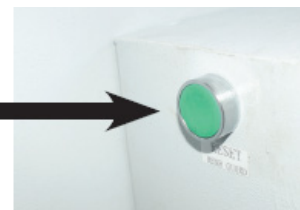



OPERATION MANUAL

4.2 OMROM E3Z SAFETY SENSOR ALIGNMENT. CONT.

Identifying Sensors

Sender

The sender has one red light on top of the unit and one red light at the front. These two lights will be on at all the times while the machine has power.



Receiver

The receiver has two lights on top of the unit. The receiver should have one green light on or a red and green light on when all the sensors have been aligned correctly.



**Receiver - No lights on.
Indicates no power supply.**



**Receiver - Green light on.
Indicates power is on but
not aligned.**



**Receiver - Red & Green
lights on. Indicates power is
on & aligned.**

Note: No.1 receiver could be mounted top, middle or bottom on the guard.

The receivers are wired in series so No.1 receiver will have a green light on, indicating it has power. When it is correctly aligned with its sender the red & green light will be on and it will send power to No.2 receiver.

No.2 receiver will have a green light on and when that receiver has been correctly aligned with its sender the red & green light will be on and it will send power to the No.3 receiver.

No.3 receiver is aligned using the same technique.

So when all 3 receivers are aligned correctly with their corresponding senders they should all have red and green lights on top of each unit.



OPERATION MANUAL

4.2 OMROM E3Z SAFETY SENSOR ALIGNMENT. CONT.

Alignment of Senders & Receivers

Ensure that the machine is level and all four leveling jacking bolts are correctly adjusted. Check the rear guards are bolted tight and adjust the stabilizing feet to ground level to support the guards. The sensors are sensitive to alignment so try to align as accurately as possible. If the sender is only just aligned with the receiver, any vibration when cutting will stop the motor and the safety circuit will have to be reset again.

Loosen the sender screws and angle the sender up until the receiver loses alignment.

Angle sender down until the receiver re-aligns and then loses alignment again.

Half way between these two positions is the most accurate alignment.

The sensors may also have to be angled sideways as well to get the best possible alignment. This may involve packing individual brackets or sensors.

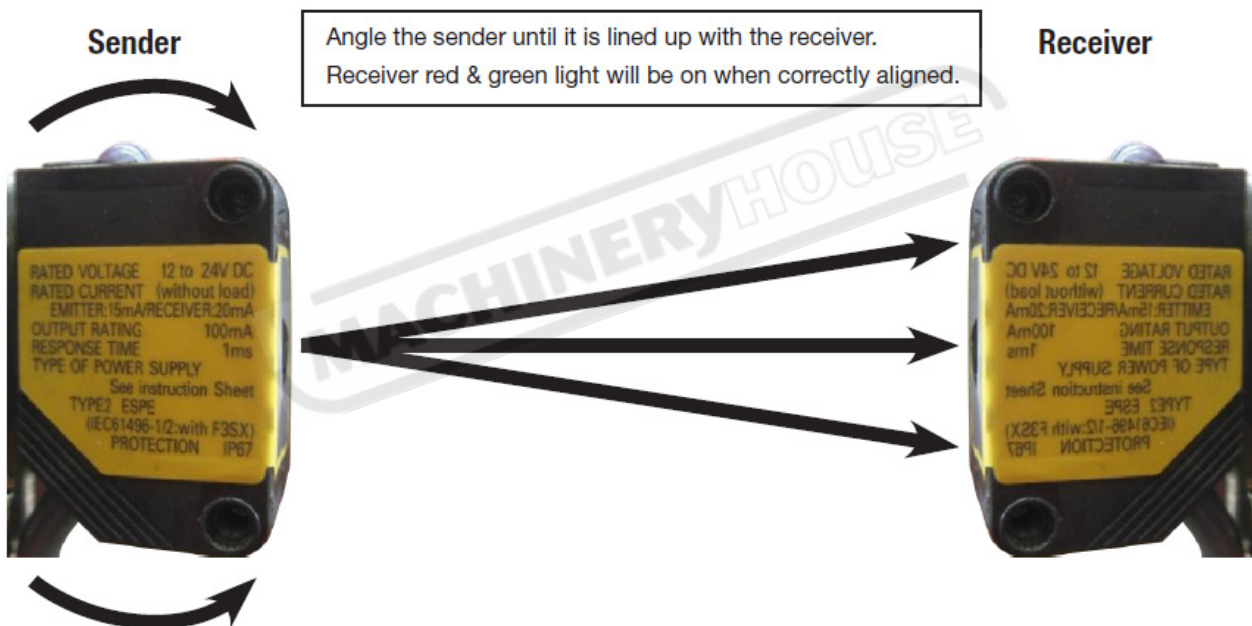

You can now reset the safety circuit & press the reset button

After a successful reset the light on the control panel will not be illuminated and the machine is ready to operate.

Fig. 1



OPERATION MANUAL

4.3 MANUAL BACK GAUGE.

The back gauge consists of a left and right hand shafts fitted with a rack and pinion. Mounted on each shaft is a sliding block that slides along the rack shaft carrying the back gauge. The racks are connected by a shaft and handwheel. When turning the hand wheel the back gauge is moved in and out. The shaft can also be used for adjusting the synchronizing of the two ends of the back gauge to keep them parallel.

The right rack shaft is fitted with a scale with graduations of 0.5mm. When installing the machine for the first time or after grinding the blade, you should carefully adjust the “zero” position,

The two sliding blocks are fitted with clamping handles. After the adjustment of the gauge distance, re-clip the handles.

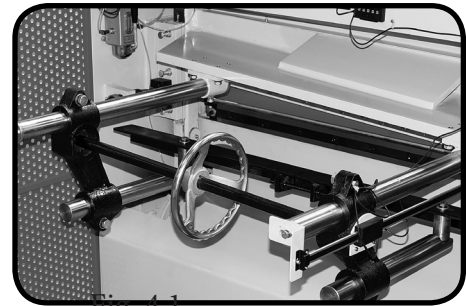

Fig. 4.1

Digital Readout

Some machines are fitted with a digital readout on the back-gauge (Fig.4.2). The adjustment can be set using the display. The display unit can be changed between inch or metric and allows for “Zero” to be selected in any position.

It also has a button (ABS) which allows a switch between absolute and incremental measurement.

E.G. First cut is at 100mm, and the second cut is at 400mm when ABS is pressed then the total of the two is displayed as “500”mm.

The digital display is attached to the right hand shaft and does not need to be reset as the scale can be “Zero” in any position. After the adjustment of the gauge distance, re-clip the handles.

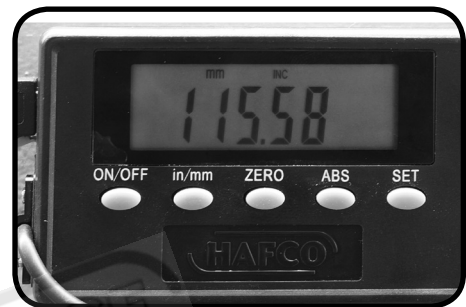

Fig. 4.2

4.4 COMMISSIONING CHECK LIST.

Before starting the machine the following checks must be carried out.

- Installation and machine preparation has been performed according to the manuals instructions.
- All grease nipple points have been lubricated.
- Electrical earth fitted and power circuits, switches, and foot-pedal checked for any damage
- Setup rear sensors
- Check motor rotation.
- Test safety operation, E stop, rear sensors, stop button etc.
- Test all mechanical operation on the machine including blade and back gauge travel and limit switch operation.
- Test cut material and check quality of cut
- Tools, equipment and personnel are clear of the machine.
- Operation Manual on how to operate the machine has been read.



OPERATION MANUAL

5. OPERATION INSTRUCTIONS

5.1 PRE-OPERATIONAL SAFETY CHECK PRIOR TO OPERATING

Before operating the machine the rear safety beam guard needs to be checked. Below are the steps that need to be followed.

1. Start machine as per instruction procedures
2. Stand outside rear safety gate & obstruct sensor (1)
3. Ensure machine has stopped and is disabled
4. Check your control: Warning light (A)
5. Press green reset button at the rear of electrical box image (C)
6. If red light on control panel is off continue to step 7
7. Repeat steps 1 to 6 for each sensor (2) & (3)

A: Basic Control - Light on



B: Rear Guarding Sensors



C: Guard Reset Button



Emergency Stop Check,

1. Start machine as per instruction procedures
2. Press the emergency stop buttons on the control panel and front of the machine. (E)
3. Ensure the machine has stopped and is disabled
4. Reset emergency stop button by twisting the red dial. (D)
- (Some models need guard to also be reset)
5. Repeat steps 1 to 4 for each emergency stop on your machine

E: Emergency Stop



D: Guard Reset Button



5.2 STARTUP

Before starting the machine ensure that the manual has been read and understood.

1. Switch the isolating switch on (Fig 1.) The “Power On Light” ① (Fig.2) will be illuminated.

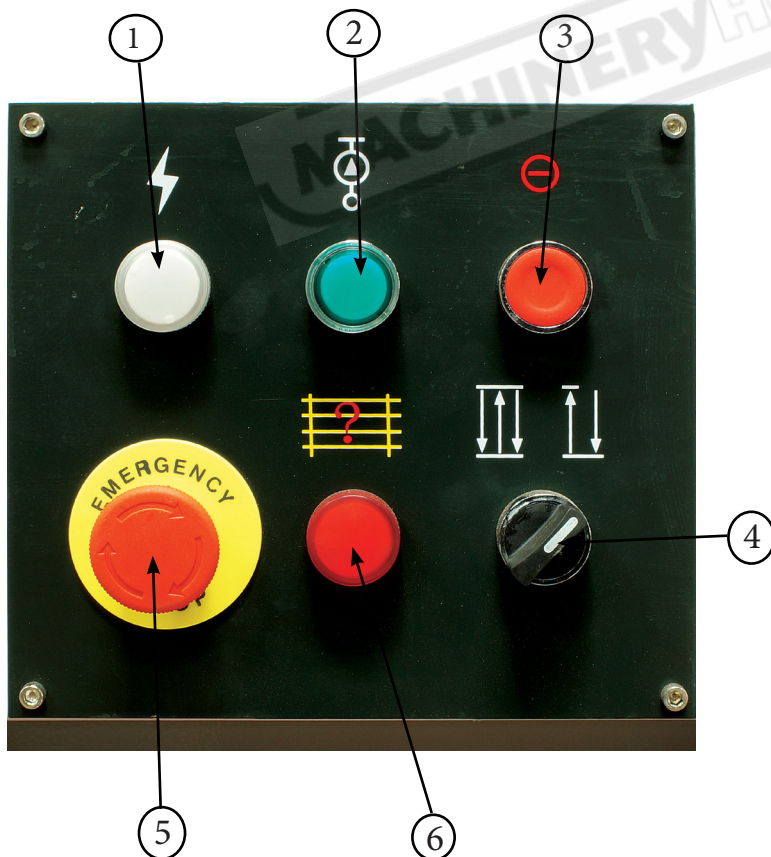

Fig 1.

2. If all the safety checks have been done then press the “Start” button to energise the electrics. (Fig 2.)

Now the pedal can be depressed to start the cut

NOTE! The “Start Button” must be illuminated for the pedal to operate.



1	Power ON Light
2	Illuminated Start Button
3	Electrics OFF
4	Continuous or Single cut
5	Emergency Stop
6	Rear Safety Guard

Fig 2.



OPERATION MANUAL

5.3 ADJUSTING OF THE BLADE GAP

Check the maximum cutting capacity of the guillotine.. This can be found on the specification plate on the machine. The capacity listed is for Mild Steel. Stainless steel capacity can be found in the specification table in this manual. (Page 4)

Check The Blade Gap Setting

The machine is supplied from the factory with the blade gap set to the capacity of the machine.

NOTE! It is extremely important that the blade gap must be reset to suit the thickness of the material every time the size of the materials changes. Failure to do this could cause damaged to the machine

The blade gap should be approximately 10% of the thickness of the material.

- E.G. 1mm material = 0.1mm Blade Gap
- 2mm material = 0.2mm Blade Gap

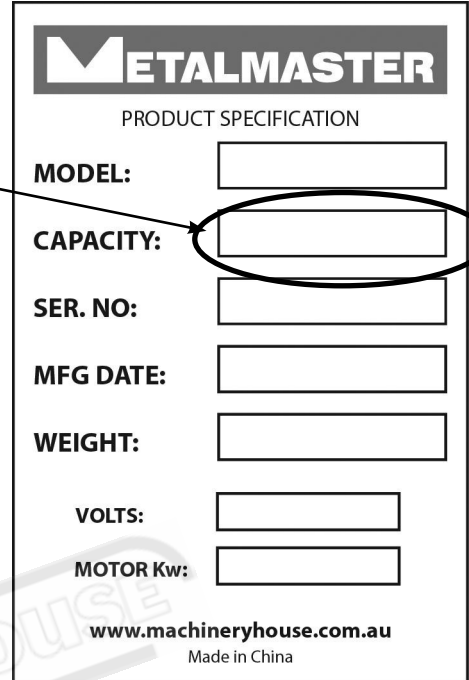

Adjusting the Blade Gap

Step 1. Isolate the machine from the power supply and place a maintenance tag on the electrical cabinet.

Step 2. The 4 head bolts at both ends of the machine should not be tightend up too tight. The gap should be able to be adjusted with out undoing the bolts. If they need to be loosened to adjust the blade gap, be sure they are tightened only slightly. (Fig.5.3)



Fig. 5.3

Step 3. Set the rapid blade adjustment to the correct gap. Repeat the operation at the opposite end of the machine to ensure that the blade is parallel. (Fig. 5.4)

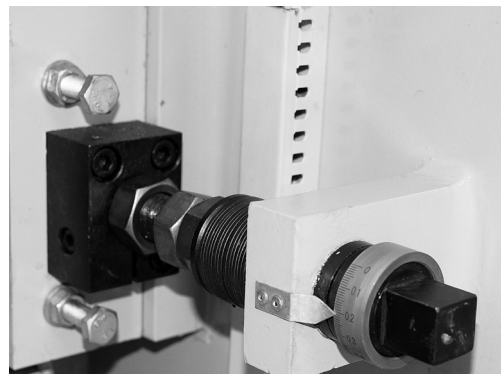

Fig. 5.4

Step 4. Re-tighten the head bolts at both ends of the machine. Do not over tighten the bolts as this can reduce the set blade gap



OPERATION MANUAL

6. MAINTENANCE

6.1 TYPE AND FREQUENCY OF INSPECTIONS

Inspection	Period	Responsibility
Lubrication of all grease points	Daily	Operator
Lubrication of slideways	Weekly	Operator
Guide surface of hold-down plate	Daily	Operator
Gear and Rack of the Back Gauge	Monthly	Operator
Bearing of the Main Shaft	6 Month	Planned Maintenance
Brass Bush for eccentric sleeve	Daily	Operator
Shaft pin of the connecting rod	Monthly	Operator
Gearbox	6 Month	Planned Maintenance
All Guards that protect against physical damage	Daily	Operator
Machine fixing bolts against loosening	Weekly	Operator
Safety & limit switches against loosening, or damage	Weekly	Operator
Terminal connections of the electrical installation	Annually	Electrician

Fig. 5.4

6.2 LUBRICATION POINTS

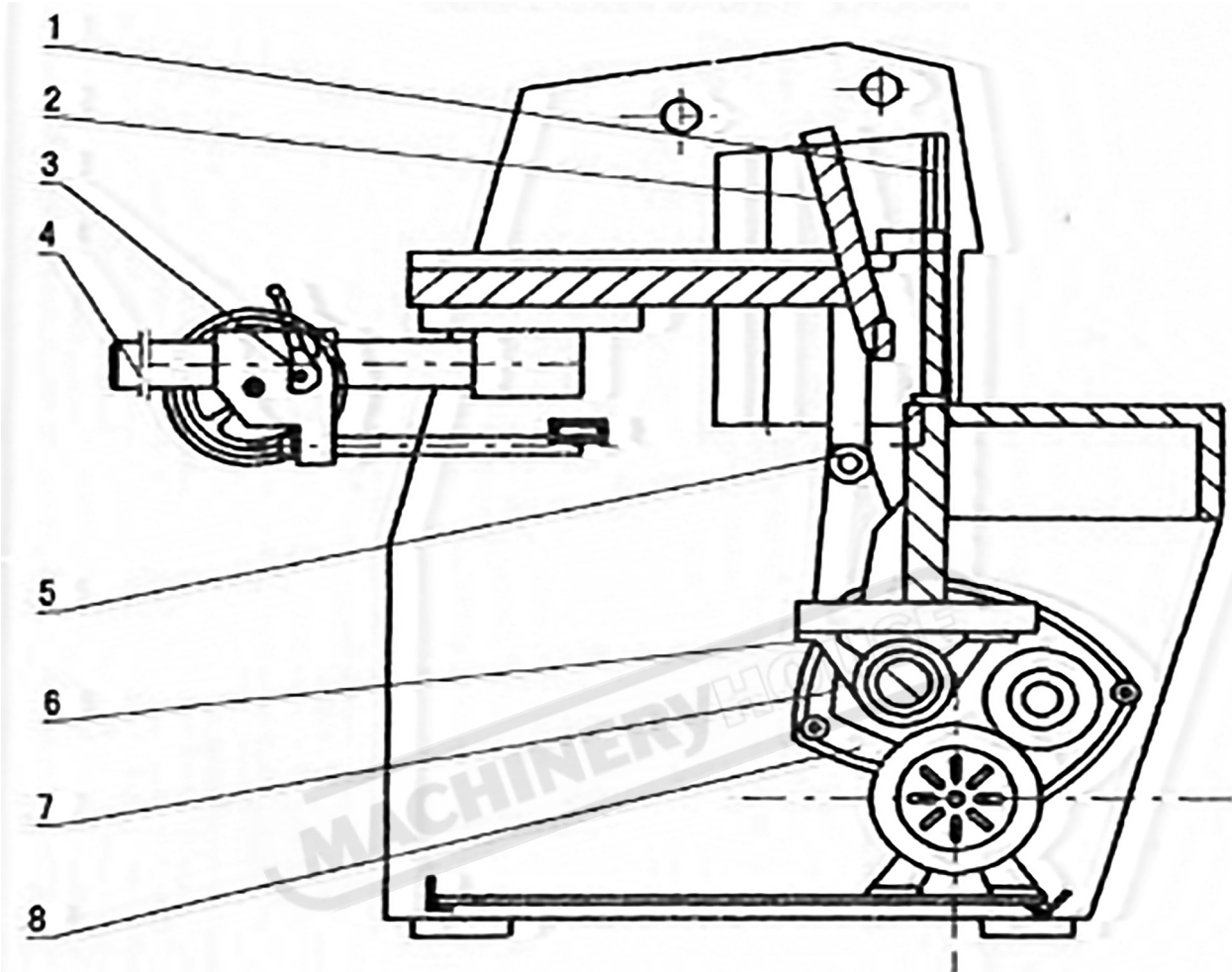

No.	Position	Tools	No. Points	Lubrication
1	Guide surface of hold down plate	Manually	2	ZG-3 Grease
2	Guide surface of the blade beam	Oil Gun	2	
3	Back gauge gear	Manually	2	
4	Back gauge rack	Manually	2	
5	Connecting Rod shaft pin	Manually	2	
6	Copper bush for eccentric sleeve	Oil gun	2	
7	Main shaft bearing	Oil gun	4	HJ-30 Mechanical Oil
8	Gear box	Oil pump	1	



OPERATION MANUAL

6.3 BRAKE ADJUSTMENT

The following procedure is for the adjustment of the motor brake.
The air gap on the motor brake should be 0.3-0.4mm

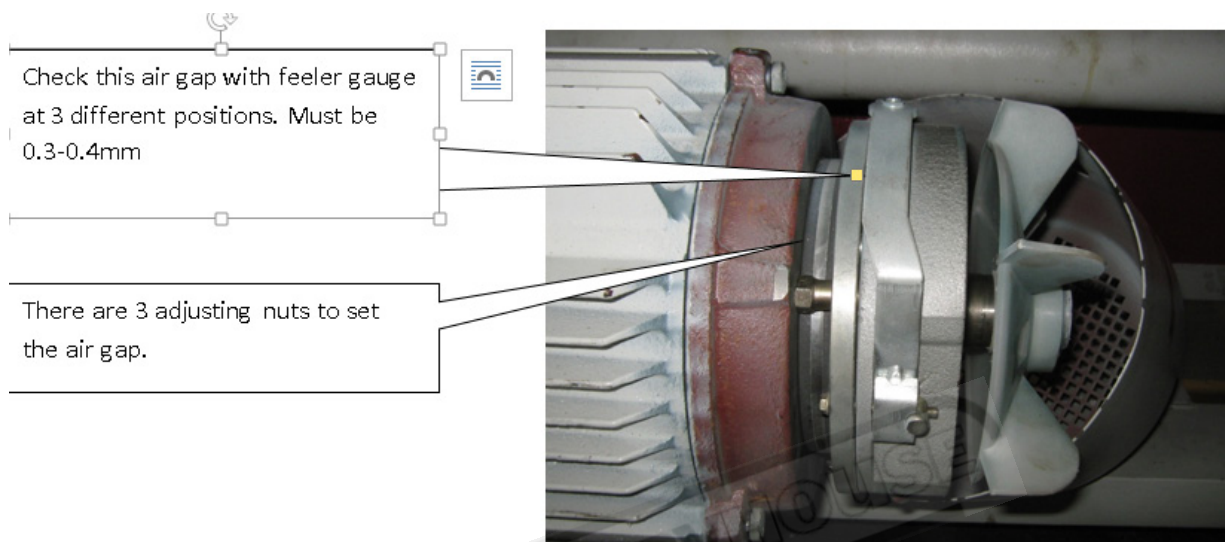

Step 1. Loosen the 3 bolts



Step 2. Adjust the 3 nuts. Make sure that the gap is the same all the way round.



Step 3. Tighten the 3 bolts that were loosen in step 1.

6.4 CALIBRATE RAPID BLADE ADJUSTMENT DIAL.

Set the blade gap to 0.2mm (Fig. 1) and then measure blade gap with feeler gauge. If incorrect re-adjust blade gap to measure 0.2mm with feeler gauge (Fig. 2) and then re-calibrate the graduated dial ring to read 0.2mm. Repeat both ends.

(Graduated Dial ring has a locking screw/nut that must be loosened. Set the blade gap at 0.2mm and then measure the blade gap with a feeler gauge. If incorrect re-adjust blade gap to measure 0.2mm with feeler gauge and then re-calibrate the graduated dial ring to read 0.2mm. Repeat both ends.

(Graduated Dial ring has a locking screw/nut that must be undone to adjust)

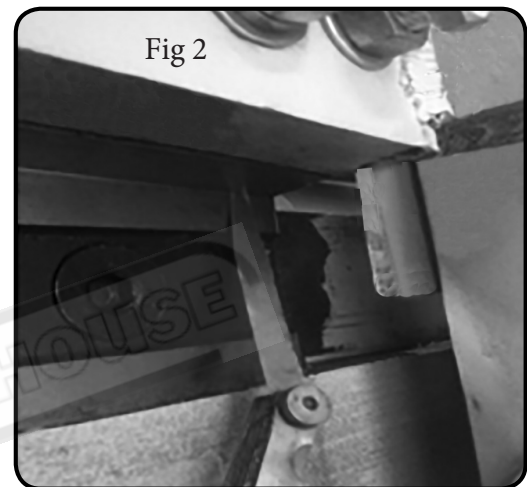
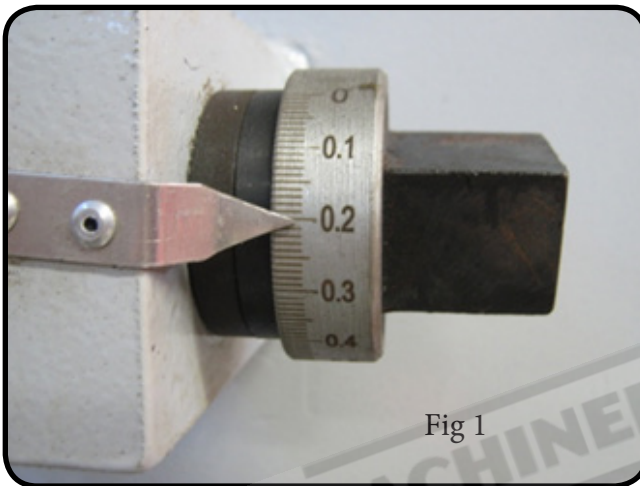

6.5 CHECK MINIMUM BLADE GAP SAFETY SETTING.

The factory gap setting is 0.1mm minimum

Adjust the Rapid blade adjustment to 0 (Fig. 3) and use a feeler gauge to measure the blade gap. If needed adjust front blade dead stop (Fig. 4) till gap measures 0.1mm. The blade gap on this machine must not be able to go smaller than 0.1mm.

Repeat the process at both ends

(Graduated Dial ring has a locking screw/nut that can be undone to adjust)

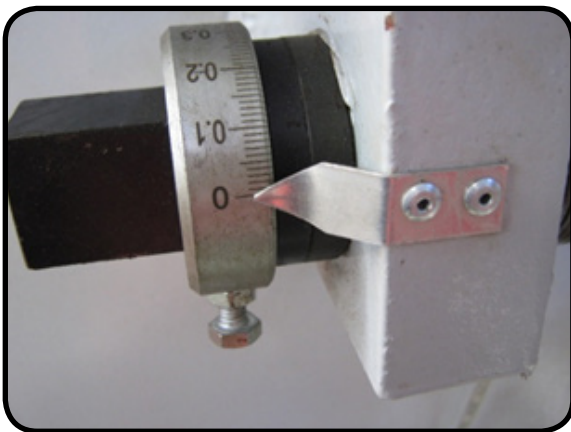

6.5 TOP POSITION CAM ADJUSTMENT

Adjustment when the machine does not return to the top position: To check that the operation is correct, depress the pedal and allow the machine to cycle until it stops. If it doesn't stop in the top position then adjustment needs to be made. Inch the beam until it reaches the top position.

Loosen the positioning screw and rotate the cam until the travel switch moving arm roller is in line with the highest part of the cam. Adjust the adjusting screw of the moving arm until the micro switch is closed then re clamp it.

Depress the pedal and check if the machine returns and stops in the top position. If the position is incorrect repeat the adjustment again.

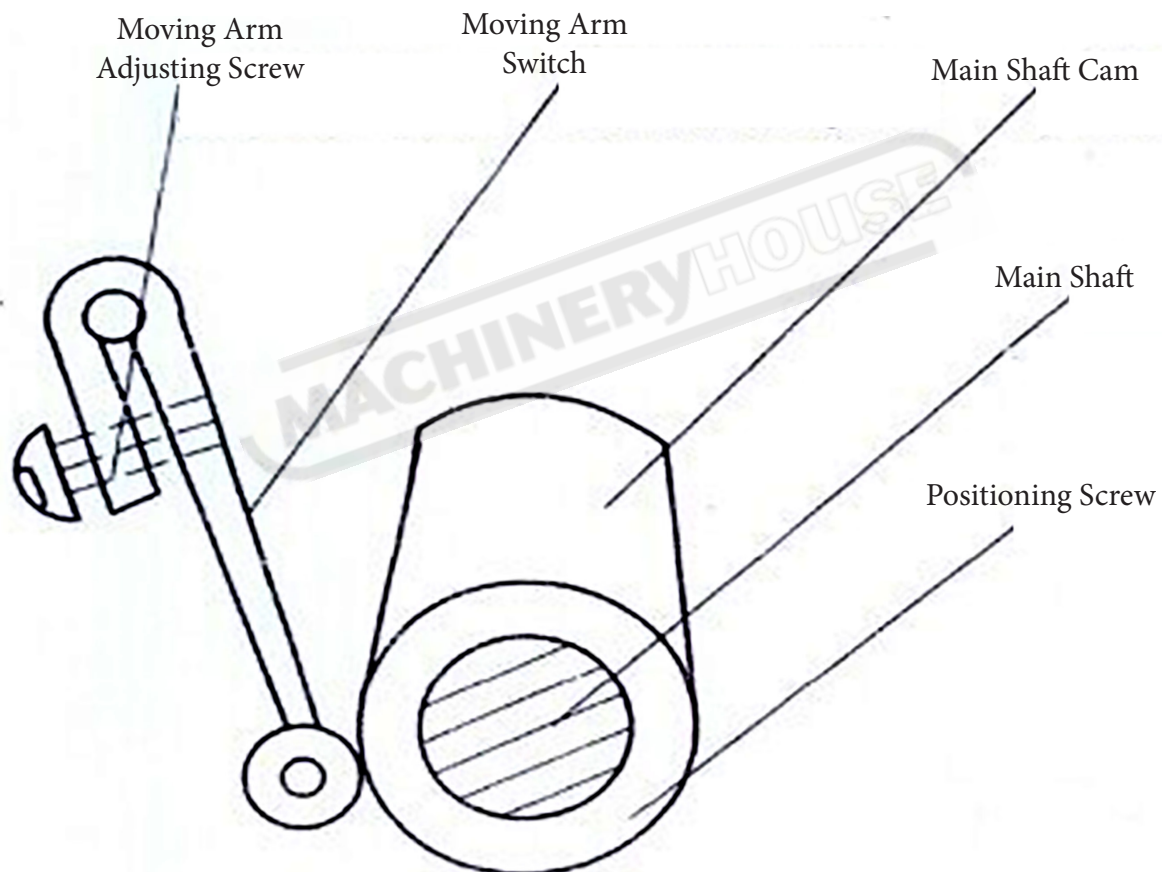



OPERATION MANUAL

A. ELECTRICAL DIAGRAM

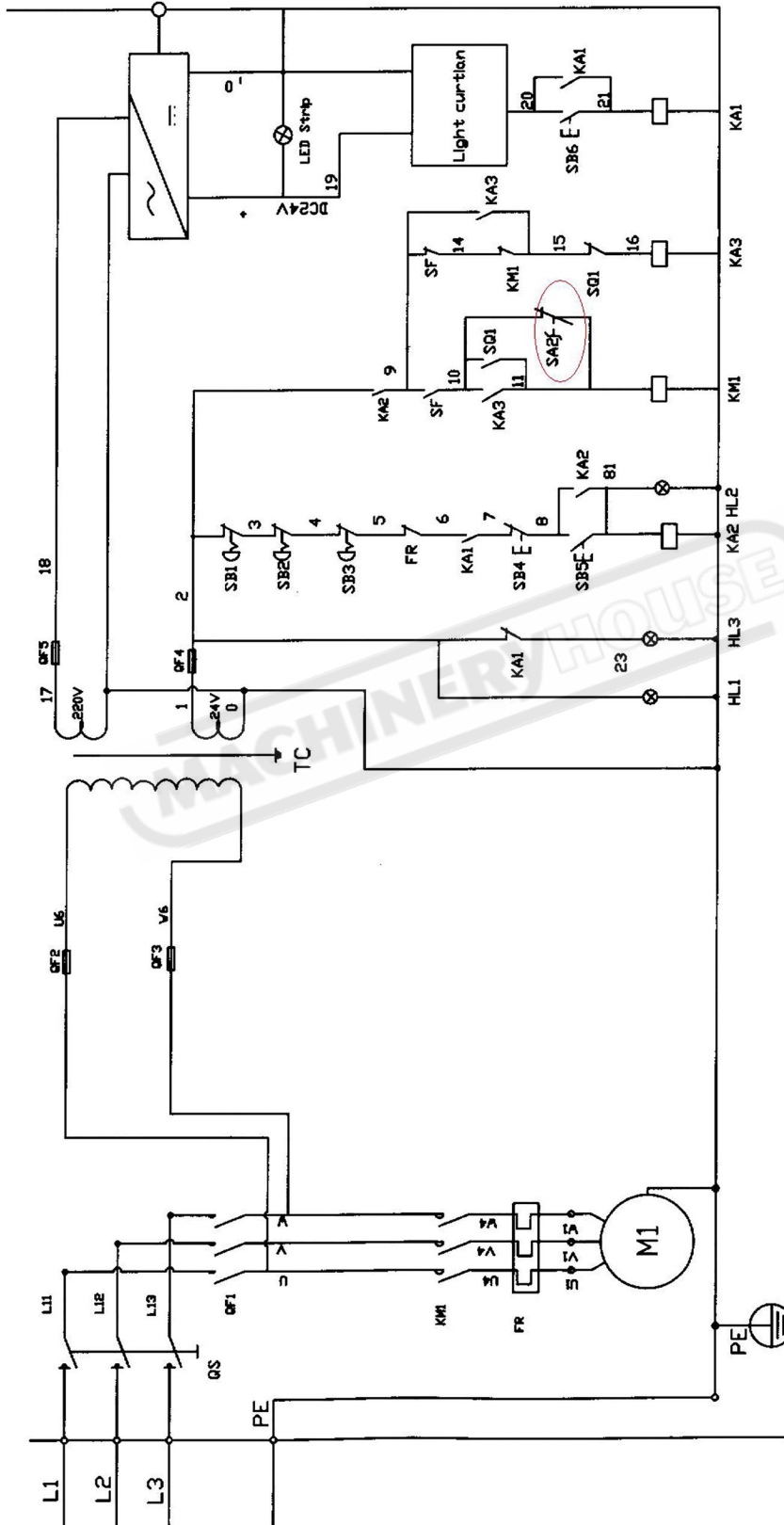

Oil pump motors, circuit breakers and contactors variable parameter list

Electrical Code	Model	Motor Model	Power Current	Speed	Circuit Breaker Model (QF)	Contactors Type (KM)
M1		Y132M-4	7.5KW	1440r/min	G2-ME20C	LC1-D1810N
		Y112M-4	4KW	1440r/min	(13-18)A	LC1-D2501N



WARNING

General Machinery Safety Instructions

Machinery House
requires you to read this entire Manual before using this machine.

- 1. Read the entire Manual before starting machinery.** Machinery may cause serious injury if not correctly used.
- 2. Always use correct hearing protection when operating machinery.** Machinery noise may cause permanent hearing damage.
- 3. Machinery must never be used when tired, or under the influence of drugs or alcohol.** When running machinery you must be alert at all times.
- 4. Wear correct Clothing.** At all times remove all loose clothing, necklaces, rings, jewelry, etc. Long hair must be contained in a hair net. Non-slip protective footwear must be worn.
- 5. Always wear correct respirators around fumes or dust when operating machinery.** Machinery fumes & dust can cause serious respiratory illness. Dust extractors must be used where applicable.
- 6. Always wear correct safety glasses.** When machining you must use the correct eye protection to prevent injuring your eyes.
- 7. Keep work clean and make sure you have good lighting.** Cluttered and dark shadows may cause accidents.
- 8. Personnel must be properly trained or well supervised when operating machinery.** Make sure you have clear and safe understanding of the machine you are operating.
- 9. Keep children and visitors away.** Make sure children and visitors are at a safe distance for you work area.
- 10. Keep your workshop childproof.** Use padlocks, Turn off master power switches and remove start switch keys.
- 11. Never leave machine unattended.** Turn power off and wait till machine has come to a complete stop before leaving the machine unattended.
- 12. Make a safe working environment.** Do not use machine in a damp, wet area, or where flammable or noxious fumes may exist.
- 13. Disconnect main power before service machine.** Make sure power switch is in the off position before re-connecting.
- 14. Use correct amperage extension cords.** Undersized extension cords overheat and lose power. Replace extension cords if they become damaged.
- 15. Keep machine well maintained.** Keep blades sharp and clean for best and safest performance. Follow instructions when lubricating and changing accessories.
- 16. Keep machine well guarded.** Make sure guards on machine are in place and are all working correctly.
- 17. Do not overreach.** Keep proper footing and balance at all times.
- 18. Secure workpiece.** Use clamps or a vice to hold the workpiece where practical. Keeping the workpiece secure will free up your hand to operate the machine and will protect hand from injury.
- 19. Check machine over before operating.** Check machine for damaged parts, loose bolts, Keys and wrenches left on machine and any other conditions that may effect the machines operation. Repair and replace damaged parts.
- 20. Use recommended accessories.** Refer to instruction manual or ask correct service officer when using accessories. The use of improper accessories may cause the risk of injury.
- 21. Do not force machinery.** Work at the speed and capacity at which the machine or accessory was designed.
- 22. Use correct lifting practice.** Always use the correct lifting methods when using machinery. Incorrect lifting methods can cause serious injury.
- 23. Lock mobile bases.** Make sure any mobile bases are locked before using machine.
- 24. Allergic reactions.** Certain metal shavings and cutting fluids may cause an allergic reaction in people and animals, especially when cutting as the fumes can be inhaled. Make sure you know what type of metal and cutting fluid you will be exposed to and how to avoid contamination.
- 25. Call for help.** If at any time you experience difficulties, stop the machine and call you nearest branch service department for help.

WARNING

Power Operated Guillotine Safety Instructions

Machinery House
requires you to read this entire Manual before using this machine.

- 1. Maintenance.** Make sure the Guillotine is turned off and disconnect from the main power supply and make sure all moving parts have come to a complete stop before any inspection, adjustment or maintenance is carried out.
- 2. Guillotine Condition.** Guillotine must be maintained for a proper working condition. Never operate a Guillotine that has low oil levels, damaged or worn parts. Scheduled routine maintenance should be performed on a scheduled basis.
- 3. Blade Condition.** Never operate a Guillotine with a damaged or badly worn blades. Replace if required.
- 4. Pump Direction.** Pump rotation must be in arrow direction otherwise the pump will be damaged.
- 5. Hand Hazard.** Keep hands and fingers clear from moving parts. Serious injury can occur if hand or finger tips come between blades.
- 6. Personal Protection.** Gloves are recommended when handling the workpieces.
- 7. Authorized and trained personnel.** The machine must be operated by authorized and trained personnel. The shear is designed to be operated by a single user. Using the machine with more than one operator is forbidden, except for certain maintenance situations.
- 8. Power outage.** In the event of a power failure during use of the machine, turn off all switches to avoid possible sudden start up once power is restored.
- 9. Work area hazards.** Keep the area around the Guillotine clean from oil, tools, objects & chips. Pay attention to other persons in the area and know what is going on around the area to ensure unintended accidents.
- 10. Guards.** Operate machine only with all protective devices and guarding in place and operational. Never remove, defeat or bypass. Any presence-sensing safeguarding used must have regular Safety integrity tests and records kept. These records must be kept for 5 years or for the life of the plant and be handed to any person that you relinquish control of the plant to. Tests include stop time measurements, safety distance calculations and inspections, with operator checks and periodic maintenance checks. (WHS Regulation 226)
- 11. Material.** Material must NOT be hardened ceramic or glass-originated, non flat metals (at origin) e.g. rods, bars, tubes & pipes.
- 12. Blade gap adjustment.** Do NOT operate the machine without proper blade gap adjustment according to sheet thickness.
- 13. Warning Labels.** Take note of any warning labels on the machine and do not remove them.
- 14. Backgauge Area.** Do not access the backgauge area, while the machine is working.
- 15. Protective fence.** Do not bridge the safety limit switch of the rear protective fence.
- 16. Squaring arm.** Do not use side squaring arm and front support arms for intermediate storage of workpieces.
- 17. Operation.** During the shearing process, the workpiece may slide or move unexpectedly. Therefore, the material must be handled carefully.
- 18. Emergency stop.** Use the emergency stop button in case of any emergency.
- 19. Level machine.** Level the machine on a flat concrete surface by using a spirit level.
- 20. Overloading machine.** Do not exceed the rated capacity of the guillotine. Please refer to the manual for capacities.
- 21. Hearing protection and hazards.** Always wear hearing protection as noise generated from machine and workpiece can cause permanent hearing loss over time.
- 22. Call for help.** If at any time you experience difficulties, stop the machine and call your nearest branch service department for help.

PLANT SAFETY PROGRAM

NEW MACHINERY HAZARD IDENTIFICATION, ASSESSMENT & CONTROL

Power Operated Guillotine

Developed in Co-operation Between A.W.I.S.A and Australia Chamber of Manufactures
This program is based upon the Safe Work Australia, Code of Practice - Managing Risks of Plant in the Workplace (WHSA 2011 No10)

Item No.	Hazard Identification	Hazard Assessment	Risk Control Strategies <small>(Recommended for Purchase / Buyer / User)</small>
B	CRUSHING	LOW	Secure & support work material on table.
C	CUTTING, STABBING, PUNCTURING	MEDIUM	Wear gloves to prevent cuts from sharp material offcuts.
D	SHEARING	MEDIUM	Hands should be kept clear of moving parts and blades. Isolate power to machine prior to any checks or maintenance. Ensure front blade guard is fitted securely. Do not adjust or clean until machine has fully stopped. Access to the rear of machine must be interlock or photoelectric guarded to prevent access when the machine is operating, (see workover authority principles of machine guarding for guidelines).
F	STRIKING	MEDIUM	Wear safety glasses. Stand clear of falling offcuts. Ensure material hold downs are correctly adjusted. Ensure guards are secured properly.
H	ELECTRICAL	MEDIUM	Machine should be installed & checked by a Licensed Electrician. All electrical enclosures should only be opened with a tool that is not to be kept with the machine.
O	OTHER HAZARDS, NOISE.	LOW	Wear hearing protection as required.
Plant Safety Program to be read in conjunction with manufactures instructions			



www.machineryhouse.com.au



www.machineryhouse.co.nz

Authorised and signed by:

Safety officer:

Manager:

Revised Date: 25th Sept 2015